

Multi-feed Auto Soap Dispenser System

Multi-feed auto soap dispenser system - the smart system which allows one to install up to 6 auto soap dispensers above the counter, with one centralized soap tank. The fill port is equipped with a low soap level and overfilled protection indication LED light and sound.

With a 6-liter refillable soap tank, this is the solution for big construction projects and high traffic places. Now imagine the maintenance cost you could save by adopting our smart system!

Available Spout Design



Capacity: 6L

Power Indicator: Red light lights on for 3 sec

Low Battery Indicator: Red light flashing

Low Soap Level Indicator: Green light starts to flash when soap level is below 25~30%

Full Soap Indicator: Green light stops flashing, indicating sound goes on for 15 sec

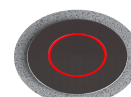
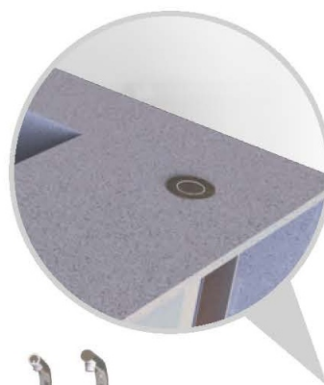

Low Battery

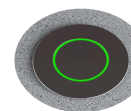

Low Soap Level

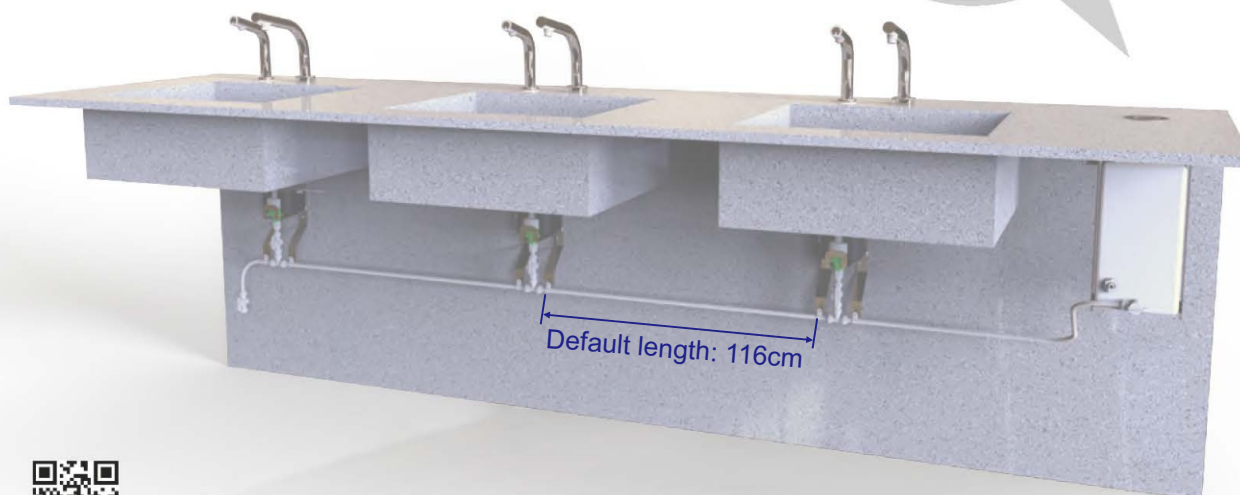

MULTI-FEED

Specification

Wall Mounted Soap Dispenser



EcoTap-W SD

Spout Material: S/S#304
 Spout Finish: Satin or Bright
 Power Source: AC (6V)

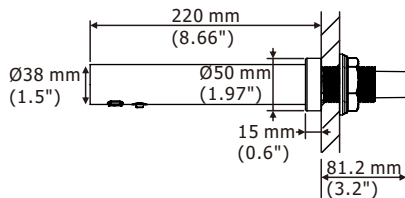

Deck Mounted Soap Dispenser



EcoTap-D SD

Spout Material: S/S#304
 Spout Finish: Satin or Bright
 Power Source: AC (6V)

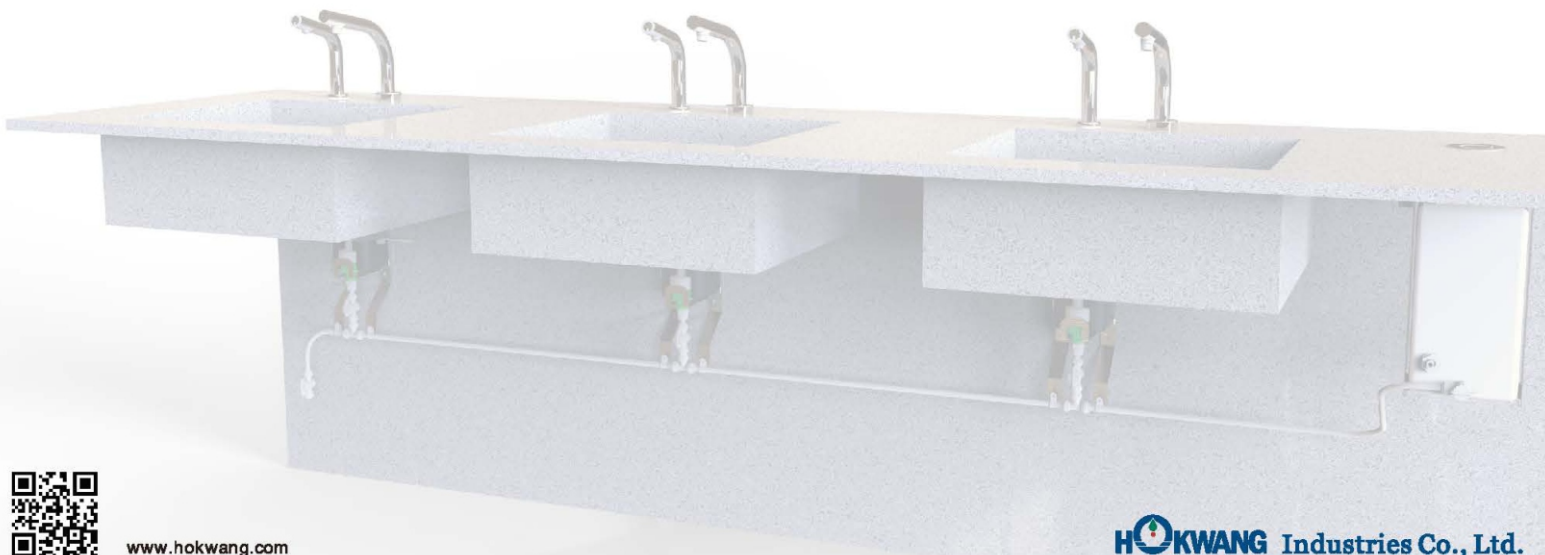
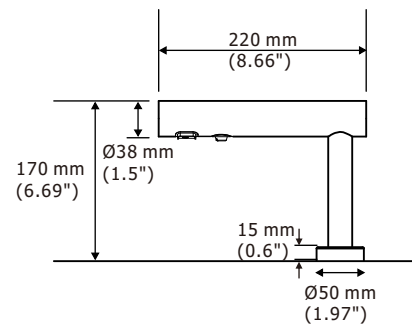

Specification

Deck Mounted Soap Dispenser



HK-CSD13/23

Spout Material: S/S#304
 Spout Finish: Satin or Bright
 Power Source: AC (6V)

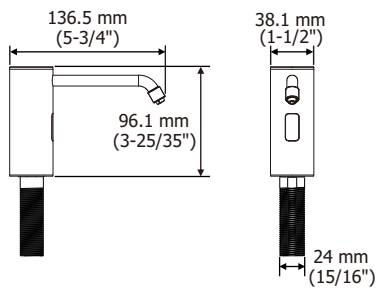

Wall Mounted Soap Dispenser



HK-CSD14R/24R

Spout Material: S/S#304
 Spout Finish: Satin or Bright
 Power Source: AC only

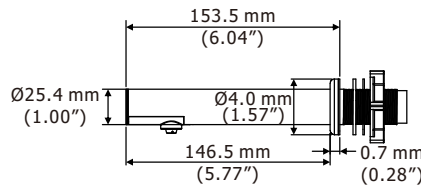

Deck Mounted Soap Dispenser



HK-CSD15R/25R

Spout Material: S/S#304
 Spout Finish: Satin or Bright
 Power Source: AC only

