

EcoFast (SM)

This is the EcoFast high speed hand dryer in a stainless steel cabinet. This model is suitable for construction projects, and users who desire a complete stainless appearance. EcoFast(SM) eco-friendly hand dryer furthermore consumes very little power (1,000 watts), while maintaining the capability to emit warm and comfortably heated air. The patented air-flow mechanism optimizes air flow to dry hands fast while saving 80% in energy costs.



HIGH SPEED RANGE

Why EcoFast(SM)?

Specs

 air speed 52-90 m/s

 standby power 0.3-0.4W

 1.0kW only

 IP11/IP13 (optional)

Design

 patented air-flow mechanism

 recessed design

 heater on/off

 sound & power adjustment

In Use

 10-15 seconds drying time

 save 80% of energy cost

 three safety protections

 60s timing protection

 easy to clean

 easy maintenance

 user friendly

Specification

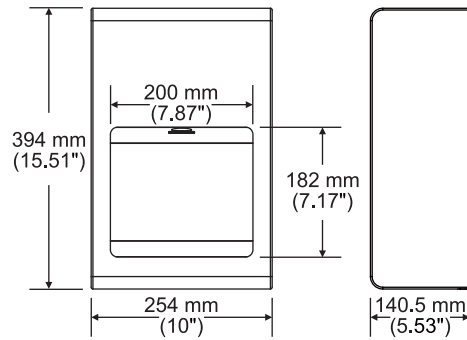

Cover Finish:	Satin Finishing
Cover Material:	Stainless Steel
Packaging (carton):	1 dryer/carton. G.W. 8.0 kg. Meas. 1.5'
Drying Time:	Less than 10-15 seconds
Operating Voltage:	110-120 Vac, 50/60 Hz, 7.6-8.4 A, 0.84-1.0 kW 220-240 Vac, 50/60 Hz, 3.8-4.2 A, 0.84-1.0 kW
Motor Wattage:	325-500 W, Adjustable
Standby Power:	0.3-0.4 W
Air Speed:	52-90 m/s, Adjustable
Sound Level:	MIN 67.4 dB to 71.2 dB MAX @ 1 m
Sensing Range:	170 ± 20 mm, Adjustable
Drip Proof:	IP11 / IP13 (optional)
Timing Protection:	60 seconds auto shut off
Motor Thermal Protection:	Auto resetting thermostat turns unit off at 95°C (203°F)
Heater Thermal Protection:	Auto resetting thermostat turns unit off at 85°C (185°F) Thermal fuse cuts unit off at 142°C (185°F)

Safety Approvals:



WEEE RoHS

